

1

2

3

4

A

A

B

B

C

C

D

D

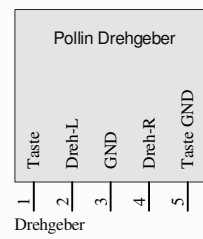
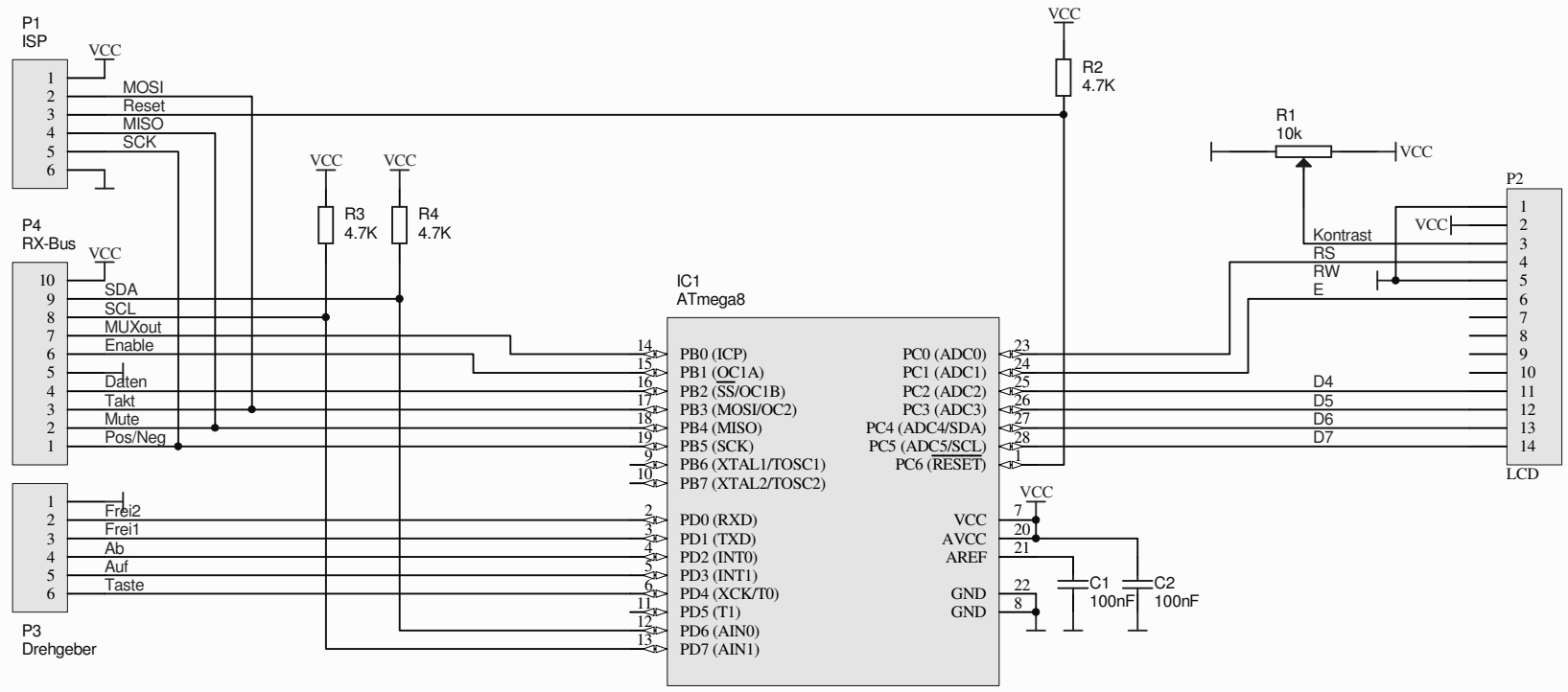

Projekt:
RX-Steuerung ATmega8 mit 2x16 LCD

Tomtom
DL1MFK

Datei: RX-BBA Controller V01.SchDoc

Rev.: **D** Datum: 15.03.2011
 Uhrzeit: 22:27:23

1

2

3

4

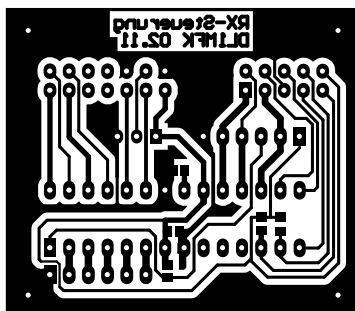

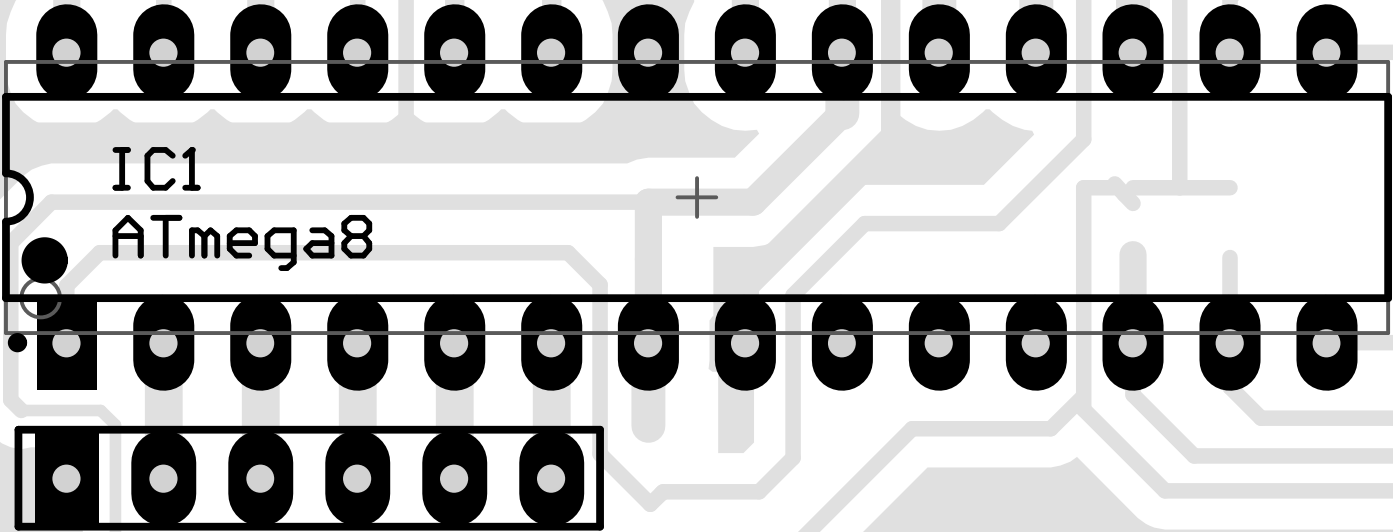
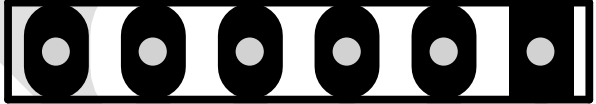
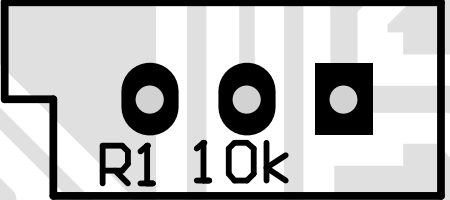
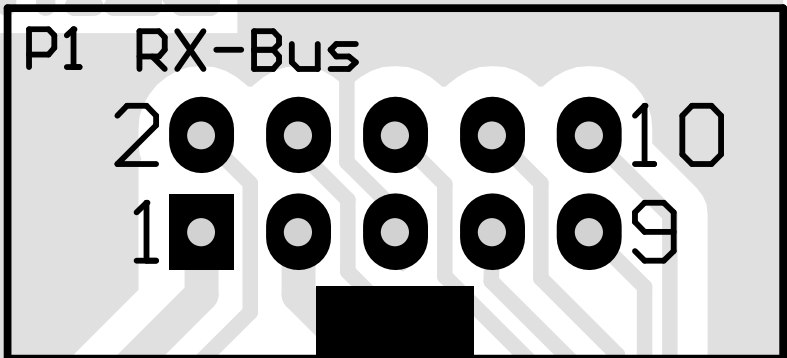
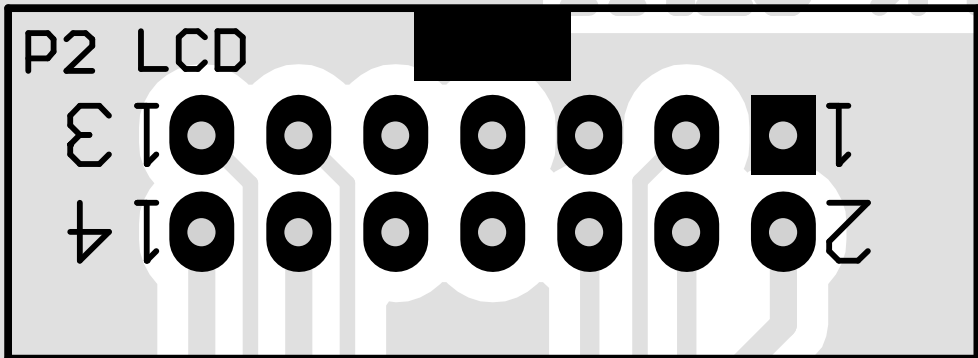

RX-Steuerung

DL1MFK 02.11

